

## GV-FE4303 4MP H.264 WDR IR Fisheye IP Camera



### Introduction

GV-FE4303 is an indoor fisheye camera that allows you to monitor all angles of a location. It can be installed to the ceiling, wall, wall corner and the pole. The camera is equipped with an IR LED ring that provides infrared illumination under low-light situations. Its distorted hemispherical image of the camera can be converted into a conventional rectilinear projection. Without installing any software, you can watch live view and utilize functions such as motion detection, privacy mask, and alert notification through the Web interface. In addition, the camera seamlessly integrates with the GV-System, providing advanced monitoring and video management features.

### Key Features

- 1/2.5" progressive scan CMOS
- Single stream from H.264 and MJPEG
- Up to 15 fps at 2048 x 1944
- Day and night (with removable IR-cut filter)
- IR ring with effective distance up to 10 m (32.81 ft)
- Vandal resistance (IK10+ for metal casing)
- Mini USB slot for WiFi Adapter or USB hard drive
- Built-in micro SD card slot (SD/SDHC) for local storage
- Built-in microphone and speaker
- Digital Object Tracking
- Provides 360° and 180° panorama view
- Different angle of view accessible by multiple users at the same time
- Playback from any view angle and zoom level
- No mechanical moving parts
- Two-way audio
- Wide Dynamic Range (WDR)
- Defog
- Tampering alarm
- Virtual PTZ function
- Auto Pan function
- Privacy mask
- Visual automation
- Text overlay
- 31 languages on Web interface
- ONVIF (Profile S) conformant

\* No Memory Card Slot & local storage function for Argentina.

Photos

Fisheye Source Image



Single View



2 x 180° View



360° View



Quad View



### Dimensions

- Camera Cover for Hard Ceiling Mount

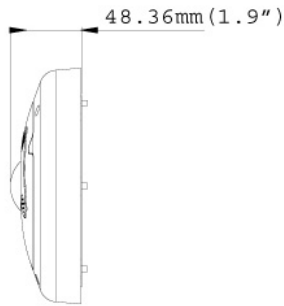
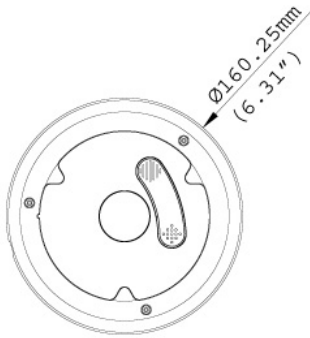

- IR LED Ring

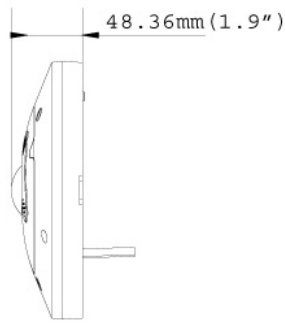
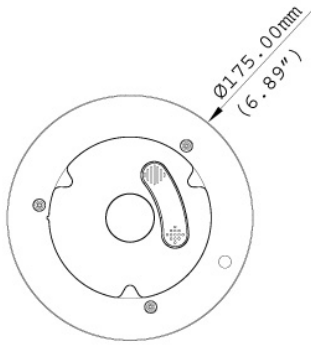

- IR LED Ring with PoE Converter

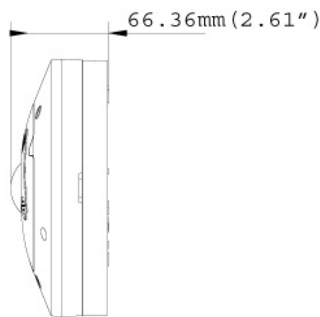
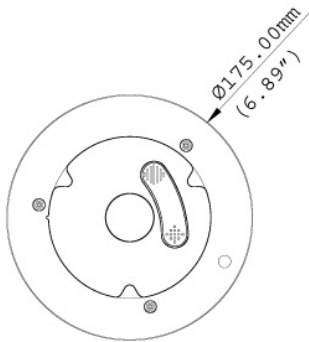

## Specifications

System Requirements		
OS	32-bit	Windows XP / Vista / 7 / Server 2008
	64-bit	Windows 7 / Server 2008
GV-System Version	GV-System V8.5.9.0 with patch or later	
Browser	Internet Explorer 7.x or later, Firefox, Google Chrome, Safari	
Camera		
Image Sensor	1/2.5" progressive scan CMOS	
Picture Elements	2048 (H) x 1944 (V)	
Minimum Illumination	Color	0.15 Lux
	B/W	0.10 Lux
	IR On	0 Lux
Shutter Speed	Automatic, Manual (1/5 ~ 1/8000 sec.)	
White Balance	Automatic, Manual (2800K ~ 8500K)	
Gain Control	Automatic	
S/N Ratio	45 dB	
WDR	Yes	
Optics Lens		
Megapixel	Yes	
Day/Night	Yes (with removable IR-cut filter)	
Lens Type	Fixed	
Focal Length	1.05 mm	
Maximum Aperture	F/2.8	
Mount	M12, Pitch 0.5 mm	
Image Format	2.5"	
Horizontal FOV	180°	
Operation	Focus	Fixed
	Zoom	Fixed
	Iris	Fixed
IR LED Quantity	6 IR LEDs	
Max. IR Distance	10 m (32.81 ft)	
Operation		
Video Compression	H.264, MJPEG	
Video Streaming	Single stream from H.264 or MJPEG	
Frame Rate	15 fps at 2048 x 1944, 1440 x 1376, 1280 x 1200 *The frame rate and the performance may vary depending on the number of connections and data bitrates (different scenes).	
Image Setting	Brightness, Contrast, Saturation, Sharpness, Gamma, White Balance, Flicker-less, Image Orientation, Shutter Speed, D/N, Backlight Compensation, WDR, Defog	
Audio Compression	G.711, AAC (optional)	
Audio Support	Two-Way Audio	
Video Resolution		
Main Stream	2048 x 1944, 1440 x 1376, 1280 x 1200	
Network		
Interface	10/100 Ethernet	
Protocol	FTP, DHCP, DynDNS, HTTP, HTTPS, NTP, ONVIF (Profile S), PSIA, QoS (DSCP), RTSP, SMTP, SNMP, TCP, UDP, UPnP	
Mechanical		
Temperature Detector	Yes	
Connectors	Power	2-pin terminal block, PoE
	Ethernet	Ethernet (10/100 Base-T), RJ-45 Connector
	Audio	1 In (built-in microphone) 1 Out (built-in speaker or Stereo phone jack, 3.5 mm / 0.14")

Connectors	Digital I/O	None
	Auto Iris	None
	Local Storage	Micro SD card slot (SD/SDHC, SD version 2.0 only, Class 10) * SDXC and UHS-I card types are not supported.
<b>Mechanical</b>		
Connectors	TV-Out	None
	Mini USB	GV-WiFi Adapter or USB hard drive
<b>General</b>		
Operating Temperature		0 °C ~ 50 °C (32 °F ~ 122 °F)
Humidity		10% to 90% (no condensation)
Power Source	w/o PoE Converter	Camera: 12V DC / 24V AC / PoE (IEEE802.3af) IR LED ring: 12V DC
	w/ PoE Converter	PoE (IEEE802.3 at)
Max. Power Consumption	w/o PoE Converter	22 W
	w/ PoE Converter	30 W
Dimension	Hard-Ceiling Mount (with IR LED Ring)	∅ 175 x 48.36 mm (6.89" x 1.93")
Weight	w/o PoE Converter	870 g (1.92 lb)
	w/ PoE Converter	1.045 kg (2.3 lb)
Vandal Resistance		IK10+ for metal casing
Regulatory		CE, FCC, RCM, RoHS compliant
<b>Power over Ethernet</b>		
PoE Standard		IEEE 802.3at Power over Ethernet / PD
PoE Power Supply Type		End-Span
PoE Power Output		Per Port 48V DC, 600mA. Max. 30 watts
<b>Web Interface</b>		
Installation Management		Web-based configuration
Maintenance		Firmware upgrade through Web Browser or Utility
Access from Web Browser		Camera Live View, Video Recording, Change Video Quality, Bandwidth Control, Image Snapshot, Digital I/O Control, Audio, Picture in Picture, Picture and Picture, Motion Detection, Privacy Mask, Visual Automation, Tampering Alarm, Auto Pan Function, Virtual PTZ, Wide Angle Lens Dewarping, Text Overlay
Language		Arabic / Bulgarian / Czech / Danish / Dutch / English / Finnish / French / German / Greek / Hebrew / Hungarian / Indonesian / Italian / Japanese / Lithuanian / Norwegian / Persian / Polish / Portuguese / Romanian / Russian / Serbian / Simplified Chinese / Slovakian / Slovenian / Spanish / Swedish / Thai / Traditional Chinese / Turkish
<b>Applications</b>		
Network Storage		GV-NVR, GV-System, GV-Backup Center, GV-Recording Server
Live Viewing		IE, GV-Multi View
CMS Server Support		GV-Control Center, GV-Center V2, GV-VSM

**Note:**







1. Specifications are subject to change without notice.
2. Do not use clothes or any ordinary material to clean the camera cover since they may result in scratches.
3. Mind the following when using an inserted memory card for recording:
  - Recorded data on the memory card can be damaged or lost if the data are accessed while the camera is under physical shock, power interruption, memory card detachment or when the memory card reaches the end of its lifespan. No guarantee is provided for such causes.
  - To avoid power outage, it is highly suggested to apply a battery backup (UPS).
  - For better performance, it is highly suggested to use Micro SD card of MLC NAND flash, Class 10.
  - Replace the memory card when its read/write speed is lower than 6 MB/s or when the memory card is frequently undetected by the camera.

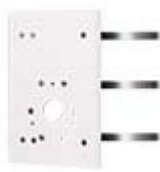
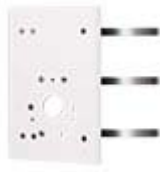

## Packing List

1. GV-Fisheye Camera
2. Support Bracket x 3
3. Camera Cover (Hard Ceiling Mount)
4. Camera Cover (In-Ceiling Mount)
5. Screw (Hard Ceiling Mount) x 3
6. Screw (In-Ceiling Mount) x 3
7. Torx Wrench
8. Plastic Screw Anchor x 3
9. Mini USB Extension Cable
10. IR LED Ring
11. PoE Converter set (Module, DC Power Y-Cable, RJ-45 Cable, PoE Screw x 3)
12. Installation Sticker
13. GV-Fisheye IP Camera Software DVD
14. GV-NVR Software DVD
15. GV-NVR Quick Start Guide

## Accessories

Model No.	Name		Details
GV-Mount100	Straight Tube and Junction Box Kit		Dimensions: 200 x 170 x 257.5 mm (7.9" x 6.7" x 10.1") Weight: 3.17 kg (6.99 lb)
GV-Mount101	Straight Tube Kit		Dimensions: 219 x 125 x 332 mm (8.6" x 4.9" x 13.1") Weight: 1.8 kg (3.97 lb)
GV-Mount200	Wall Pendant Tube		Dimensions: 225 x 140 x 250 mm (8.9" x 5.5" x 9.8") Weight: 900 g (1.98 lb)
GV-Mount203	Wall Pendant Tube and Junction Box Kit		Dimensions: 315 x 195.5 x 225 mm (12.4" x 7.7" x 8.9") Weight: 2.95 kg (6.5 lb)
GV-Mount205	Wall Mount Bracket Kit		Dimensions: 126.5 x 203 x 160 mm / 5 x 8 x 6.3" (L x W x diameter) Weight: 0.5 kg / 1.1 lb

Model No.	Name		Details
GV-Mount300	Convex Corner Adapter Kit		Dimensions: 238.6 x 409.5 mm (9.4" x 16.1") Weight: 4.27 kg (9.41 lb)
GV-Mount310	Concave Corner Adapter Kit		Dimensions: 238.6 x 409.5 mm (9.4" x 16.1") Weight: 4.27 kg (9.41 lb)
GV-Mount400	Pole Mount Bracket Kit ( $\varnothing$ 4" ~ 6")		Bracket: 241 x 161 mm (9.5" x 6.3") Weight: 1.70 kg (3.75 lb) Steel Strap Diameter: $\varnothing$ 4" ~ 6"
GV-Mount410	Pole Mount Bracket Kit ( $\varnothing$ 6" ~ 7.5")		Bracket: 241 x 161 mm (9.5" x 6.3") Weight: 1.70 kg (3.75 lb) Steel Strap Diameter: $\varnothing$ 6" ~ 7.5"
GV-Mount702	Extension Tube		<b>Four</b> options are available. Dimensions: $\varnothing$ 5.4 x 10 or 20 or 30 or 50 cm ( $\varnothing$ 2.1" x 3.9" or 7.9" or 11.8" or 19.7") Weight: 180 g or 390 g or 550 g or 800 g (0.4 lb or 0.86 lb or 1.21 lb or 1.76 lb)
GV-Mount903	Fisheye Dome Housing		Dimensions: $\varnothing$ 186 x 97.5 mm ( $\varnothing$ 7.3" x 3.8") Weight: 700 g (1.54 lb)
GV-Mount904	Tilting Wall Mount Bracket		Dimensions: $\varnothing$ 159.1 x 40.5 mm ( $\varnothing$ 6.3" x 1.6") Weight: 400 g (0.88 lb)

Model No.	Name		Details
GV-Mount912	Power Box Mount Bracket		Dimensions: Ø 146 x 10.5 mm (Ø 5.7" x 0.4") Weight: 180 g (0.4 lb)
GV-PA191	Power over Ethernet (PoE) Adapter		The GV-PA191 is a Power over Ethernet (PoE) adapter designed to provide power to the IP device through a single Ethernet cable.
GV-POE Switch			The GV-POE Switch is designed to provide power along with network connection for IP devices. The GV-POE Switch is available in various models with different numbers and types of ports.
GV-WiFi Adaptor			Weight: 20 g (0.04 lb) Dimensions: 15 x 15 x 155 mm (0.59" x 0.59" x 6.10") Supplied with mini USB to standard USB adapter.
Power Adapter			The power adapter is available in 6 regions: Argentina, Australia, Brazil, Europe, U.K and U.S.
Power Adapter for GV-IR LED Ring			The power adapter is available in 6 regions: Argentina, Australia, Brazil, Europe, U.K and U.S.